

Canature North America Inc.

How To Install, Operate and Maintain Your Reverse Osmosis System



FILTER CARTRIDGE CONFIGURATION MAY BE SUBJECT TO CHANGE.

475 PRO SERIES

475BP PRO SERIES

INSTALLERS: PLEASE READ ALL INSTRUCTIONS BEFORE INSTALLING AND USING THIS SYSTEM.

IT IS RECOMMENDED TO WAIT UNTIL THE ENTIRE SYSTEM IS PRESURIZED (INCLUDING STORAGE TANK & FAUCET) AND RE-CHECK FOR ANY LEAKS BEFORE LEAVING INSTALLATION SITE.

IT IS NORMAL FOR SOME BLACK CARBON FINES TO APPEAR IN THE WATER WHEN EMPTYING THE FIRST 2 TANKS OF WATER. THE FIRST 2 TANKS OF WATER PRODUCED SHOULD BE EMPTIED AND NOT USED.

Table of Contents

	PAGE
How Your System Works	2
Before You Start	3
Tools Needed	3
System Location	3
Parts of the System	4
Installation Steps	4
Installing the Filters	5
Installing the Tank Ball Valve	5
Installing the Faucet	6
Installing the T Adaptor Valve	7
Installing the Waste Water Saddle	7
Installing the Unit	7
Installing Tubing Into Fittings	8
Sanitize the System	8
Installing Tubing Connections	8
Flush System and Check Operation	9
Filter Change Schedule	10
Trouble Shooting	10
Spare Parts List	11
Flow and Electrical Diagrams	12
Operation Specifications	16
Guarantee	16

How Your System Works

For best results it is recommended to install the R/O on a COLD softened water supply.

The 475 Pro Series systems use four stages of treatment to filter your water:

Stage 1 - Remove sand, dirt, sediment

Stage 2 - Remove chlorine, taste & odors, very fine particulates

Stage 3 - Reduce total dissolved minerals

Stage 4 - Polish water for refined taste

The system is compact and can be installed under the sink or another convenient place close to the faucet. The closer the proximity to the faucet the better the system flow rate.

Recommended Filter Change Schedule

Your filters require changing on a regular basis. Instructions to change them are on page 8. The schedule below is the minimum recommendation. Depending on your water conditions the filters may need to be changed more often.

Disposable Filters	Change Schedule
Sediment (SED-10)	Every 12 months
Carbon (COC-10)	Every 12 months
Carbon (GAC-10)	Every 12 months
R/O membrane	Every 24-36 months

Before You Start

- Your system contains filters which must be replaced periodically for proper operation. (Refer to Filter Change Schedule on page 8.)
- Read all steps and guides carefully before installing and using your RO system. Follow all steps exactly to correctly install.
- The system is designed to be used on potable water supplies only. If water is non-potable, additional pre-treatment will be required.
- Do not use for the treatment of water that is visually contaminated (cloudy) or has an obvious contamination source, such as contamination by raw sewage.
- All plumbing should be done in accordance with local codes and requirements.
- Non-Booster pump models work on inlet water pressures of 40 psi (minimum) to 100 psi (maximum). Booster pump models work on inlet water pressures of 15 psi (minimum) to 60 psi (maximum). If your house water pressure is over the maximum, install a pressure reducing valve in the water supply line to the filter system.
- Do not install the system outside, or in extreme hot or cold temperatures. Temperature of the water supply to the R/O system must be between 40°F and 100°F. Do not install on hot water.

Tools Needed

The following tools may be necessary, depending on the particular installation.

- 3/8" variable speed electric drill;
- 1/8", 1/4", 1/2" bits
- Center punch and hammer
- Phillips head and flat blade screw-drivers
- Adjustable wrench
- Teflon tape
- Plastic tube cutter

System Location

Your RO system may be installed under the sink, in a basement, or other location depending on available space. It is recommended the system be installed in as close a proximity to the faucet to ensure optimal system flow rate. If you have a water dispenser and or ice maker in your fridge, your RO system can be installed to provide the feed water for these features but you should consult your fridge owners manual for further information.

Guidelines for component placement are as follows:

Faucet should be placed near the sink where drinking/cooking water is normally required. A 2" flat surface is required to mount the faucet if an existing hole for a second faucet is not available. The thickness of the mounting surface should not exceed 1-1/4"

Storage tank may be placed where it is convenient, within ten feet of the faucet. Under the sink or in a nearby cabinet are excellent choices. If tank is located further than ten feet from the faucet, use 1/2" tubing to reduce pressure drop. Full tanks may weigh more than thirty pounds, so a sturdy shelf is required.

RO unit may be mounted on either side of the sink, in a cabinet or heated basement, with nearby access to a potable, cold line and a drain.

Feed water connection is accomplished with a feed water adaptor T Adaptor Valve. Locate this assembly as close to the R/O unit as possible. Connect to a potable, cold water supply line only. **NOTE:** Softened water is preferred since it will extend the life of your R/O membrane.

Drain connection is accomplished using a waste water saddle valve which is designed to fit around a standard 1-1/2" OD drain pipe. The drain saddle valve should always be installed above (before) the trap and on the vertical or horizontal tailpiece. **Refer to Figure 1.**

Parts Of The System

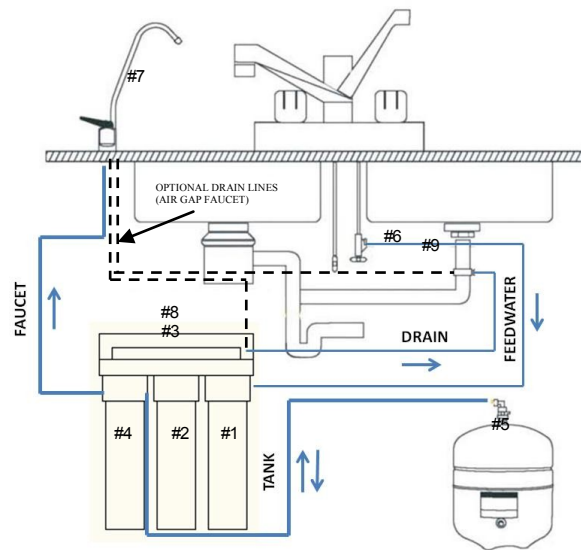

Figure 1. Typical Installation

The following components make up your Reverse Osmosis Drinking Water System:

- 1. Pre-filter (SED-10)** removes larger particles such as sand, silt, and rust.
- 2. Pre-Carbon Filter (COC-10)** removes chlorine in the feed water to protect the reverse osmosis membrane. Optional CB-10 or GAC-10 filter may also be used
- 3. Reverse Osmosis Membrane** reduces dissolved minerals, metals and salts. During the process, harmful compounds are separated by the membrane and the reject water goes to waste (drain).
- 4. Post-Carbon Filter (COC-10)** is provided for a final "polish" to provide great tasting drinking water.
- 5. Storage Tank (3.0 Gal)** holds filtered water, ready for use.
- 6. T Adaptor Valve** is connected to the cold water line to supply water to the RO system.
- 7. Faucet (Standard)** used to dispense RO water when needed. *Optional air gap and designer faucets are available.*
- 8. Automatic Shut-off Valve** senses when the storage tank is full and closes the water supply to conserve water.
- 9. Waste Water Saddle** is connected to the drain to remove reject water from the RO system.

Installation Steps

1. Cartridge Filters
2. Faucet
3. T Adaptor Valve
4. Waste Water Saddle
5. Unit Installation
6. Tubing Connections
7. Flush System and Check Operation

Installing the Filters

Remove the protective wrap from the filter cartridge. Apply NSF certified silicon grease (provided) liberally on the filter o-ring. (Failure to do this can result in a slow leak or drip if the o-ring is too dry). To install the filter simply push it up inside the cap and turn clock wise until the arrow aligns with the center of the cap. To remove the filter reverse the procedure.

Use the silicon grease provided to lubricate this o-ring.

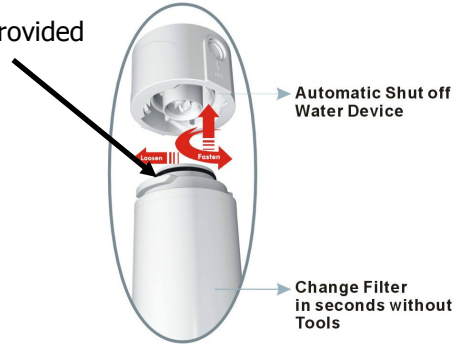

Note:

The filter head contains an Automatic Shut-off Device. This enables the filters to be changed without shutting the inlet water off. A small amount of water may leak out during the installation or removal.

It is a good idea to be aware of where the inlet water valve is located so that it can easily be turned off if any unforeseen problems are encountered.

Installing Tank Ball Valve

The RO storage tank comes with a 3/8" shut off valve that must be installed.

1. Apply 5-6 wraps of Teflon thread sealant tape to the male thread on the RO storage tank.
2. Install the shut-off valve and tighten until the gasket is compressed.

NOTES:

While there is a gasket that seals against the shut off valve, it is recommended to still use Teflon tape on the tank threads to insure a good seal is achieved. It is also recommended to check for any leaks after the system has had time to produce water and pressurize inside the storage tank. Failure to do so could result in a leak that is not spotted until after the installer has left the location.



Installing the Faucet

If the sink has a sprayer it may be disconnected for faucet installation. A pipe cap or plug will be necessary to seal the sprayer connection.

The faucet should be positioned so it empties into the sink and the spout swivels freely for convenience. If sink has a hole that can accommodate the RO faucet, no drilling is required. Proceed with mounting the faucet.

Porcelain, Enamel, Ceramic on Metal or Cast Iron Sinks

For porcelain/enamel sinks marble or granite counter tops refer to Manufacturer/Supplier for proper drilling instructions.

Installation procedures for stainless steel sinks

Recommended tools:

- Center punch
- Variable speed drill
- High speed drill bits
- Protective gloves & eye protectors

To make the faucet mounting hole (if sprayer or second hole is not used), check below to make sure the drill does not interfere with anything below the sink. Center punch a small indent at the desired faucet location. (2" flat surface is required, not exceeding 1-1/4" in thickness). Drill the 1/8" pilot hole. Drill the 1/2" hole for the faucet shank to fit through. Clean up sharp edges.

Mounting the Faucet

1. Feed the threaded nipple through sink or counter mounting hole and orient the faucet as shown. From below sink or counter, assemble the flat washer and hex nut on threaded nipple and tighten by hand. After checking faucet orientation, tighten with a wrench until secure.
2. Install the faucet adaptor fitting (shown below) and tighten until the fitting bottoms out on the o-ring inside to create the seal. Tighten with wrench until secure.
3. Insert the 3/8" tube into the quick connect fitting.



Install T Adaptor Valve On Water Supply

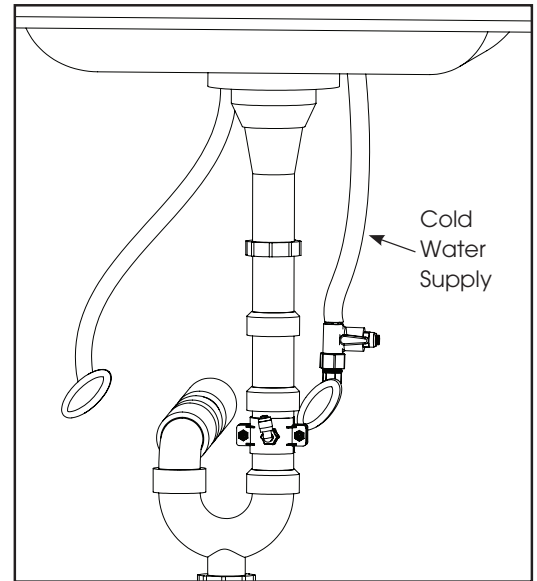
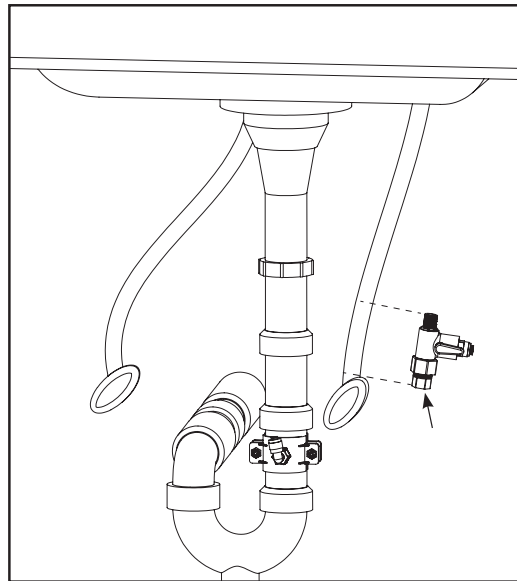
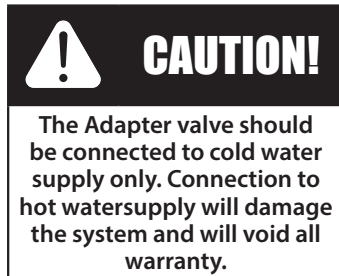
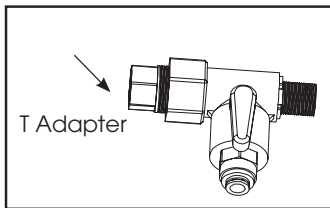

Installing the Waste Water Saddle

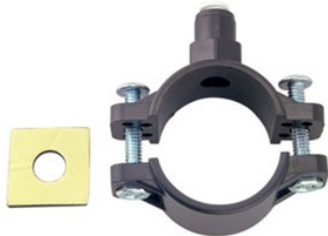

Figure 3. Waste Water Saddle

Prior to proceeding it is important to inspect the condition of drain pipes to make sure they are not thin and frail. Waste water saddles are designed to be installed on standard 1-1/2" OD drain pipe.

Install waste water saddle above (and before) the trap and on the vertical or horizontal tailpiece. Never install a waste water saddle close to the outlet of a garbage disposal or plugging of the RO drain line may result. Refer to location in Figure 3.

1. Position half of the saddle with quick connect fitting at selected location and mark for the opening.
2. Drill 1/4" hole at mark through one side of pipe. Position both halves of the saddle on drain pipe so quick connect opening lines with hole.
3. Secure drain saddle clamp with bolts and nuts provided. (Do not over tighten and make sure there is equal space between saddle halves on each side).

Installing the Unit

When installed under a sink the unit is normally mounted to the right or left sink cabinet sidewall. It is suggested to locate the system where it can be easily accessed or even removed off the hanging screws and pulled back out from the sink to change the filters.

1. Locate the unit in the desired position. Make sure it is at least 3" off the floor. Level it and mark the location of mounting screws.
2. Install the screws. Leave 1/4" of the screw head out from the wall.
3. Install the mounting bracket slots over the screws and hang the unit.

NOTE: THE UNIT MUST BE INSTALLED BY HANGING THE BRACKET ON THE WALL SO THAT THERE IS NO WEIGHT ON THE FILTERS. THE SYSTEM IS NOT DESIGNED OR INTENDED TO SIT ON THE FLOOR WITH THE WEIGHT SUPPORTED BY THE REPLACEABLE FILTER CARTRIDGES.

Installing Tubing Into Fittings

- Step 1** Cut the tube square and remove burrs and sharp edges. Ensure that the outside diameter is free from score marks. For soft or thin walled plastic tubing we recommend the use of a tube insert.
- Step 2** Push the tube into the fitting and up to the tube stop
- Step 3** Pull on the tube to check that it is secure. Test the system before use.



Sanitize System

Sanitize the System (Recommended)

Sanitizing is recommended immediately after installation of the Reverse Osmosis system. It's also recommended after servicing inner parts. It is important that the person installing or servicing the system have clean hands while handling inner parts of the system.

1. Turn off the water supply to the RO system and close the ball valve on the storage tank.
2. Open the RO faucet.
3. Use an eyedropper (not included) and common household bleach (5.25%).
4. Add 3 ml. of bleach into open end of 3/8 tube connected to tank. Handle bleach according to bleach manufacturer's recommendations.
5. Connect tubing back to tank ball valve.
6. Sanitizing the system will be completed during the Flush System and Check Operation steps on the following page.

Note: The bleach must be removed from the system before drinking the water. See Flush System instructions on the next page.

Installing Tubing Connections

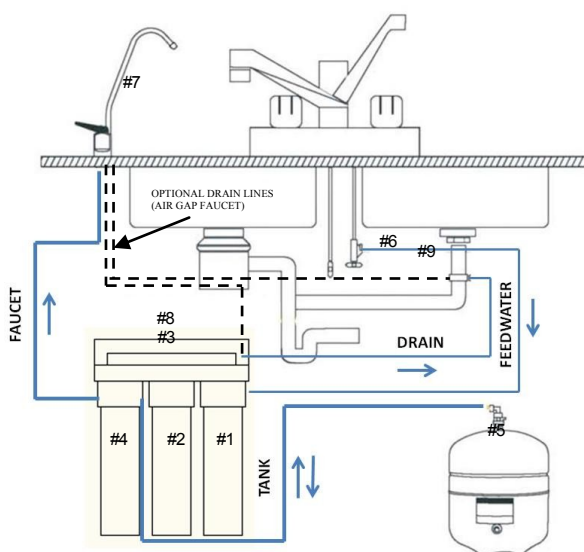

Figure 4. Tubing Connections

With all components in place, complete final tubing connections using these guidelines:

- Tubing should follow contour of the cabinets
- Cut tubing to desired length using square cuts and proper cutting device
- Make no sharp bends
- Keep tubing from the post-filter to the faucet as short as practical for good flow.
- Leave enough tubing that the system can easily be pulled out from the cabinet for easy filter changes.

Procedure (Standard Faucet)

1. Connect 3/8" tubing from faucet to RO unit.
2. Connect 3/8" tubing from tank to RO unit.
3. Connect 1/4" tubing from supply valve to RO unit.
4. Connect 1/4" tubing from drain valve to RO unit.
5. Check all connections to be sure they are secure.
6. Turn on feed water valve and check for leaks. (turn off and correct leaks if leaks occur).

Flush System and Check Operation

Start-up

1. Check all connections to be sure they are secure.
2. Turn on feed water valve and check for leaks. (turn off and correct leaks if leaks occur).
3. Close faucet and wait 5 minutes to see if leaks result. (turn off and correct leaks if leaks occur).

Flush System and Check Operation

1. Open faucet handle and allow tank to completely drain. Do not use this water. (When tank is empty, faucet will steadily drip. This is the rate the R/O system processes water).
2. Close faucet and re-inspect system for leaks.
3. Allow system to process water for approximately four hours, at which point tank will be practically full.
4. Open faucet again and allow tank to empty for a second time. Do not use this water.
5. Wait another four hours to allow tank to re-fill.

NOTE: If no objectionable tastes are noticed after second tank draining, RO processed water is ready for use. Otherwise, drain tank and re-fill for a third time

Filter Change Schedule

Recommended Filter Change Schedule

The following periodic maintenance is recommended so your system will provide years of trouble-free service:

Disposable Filters	Change Schedule
Sediment (SED-10)	Every 12 months
Carbon (CB-10)	Every 12 months
Carbon (COC-10)	Every 12 months
Carbon (GAC-10)	Every 12 months
R/O membrane	Every 24-36 months

The filters can be changed without turning off the water supply. However it is also recommended to be ready to turn the water supply off by closing the T Adaptor Valve should any problem arise.

To remove the filters follow the reverse procedure of the Installing the Filter section on page 4.

To install the filters follow the instructions from the Installing the Filter section on page 4.

Your system contains a R/O (reverse osmosis) membrane which should also be replaced periodically for proper operation. The R/O membrane may require changing more frequently depending on the source water conditions.

Change Membrane Procedure

1. Turn off water supply by turning handle on T Adaptor Valve clockwise until valve is fully closed.
2. Turn storage tank valve clockwise to close.
3. Open faucet to relieve pressure.
4. Remove quick connect fittings from R/O Membrane.
5. Connect new R/O Membrane.
6. Turn water supply back on.
7. Turn storage tank valve to open position.
8. Empty storage tank. Produce an additional full tank of water and discard it. Normal operation can resume.

Filter Change Schedule (Continued)

To Disconnect

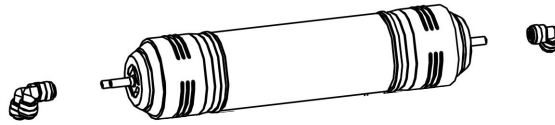

Figure 5. R/O Membrane

To disconnect, ensure that the system is depressurized, push the collect square against the fitting. With the collet held in this position the tube can be removed.



Trouble Shooting

PROBLEM	CAUSE	SOLUTION
No product water.	1. Water supply is turned off.	1. Turn on feed water.
Not enough product water.	1. Water supply is blocked.	1. Clear restriction.
	2. Filters are plugged.	2. Replace pre-filter cartridge(s).
	3. Feed water valve plugged or closed.	3. Open valve or unclog.
	4. No drain flow. Drain flow restrictor is plugged.	4. Clear or replace Flow Restrictor
Pump not running.	1. Low feed water pressure.	1. Check source water supply.
	2. No power supply or loose connection.	2. Turn on power supply.
	3. Transformer burnt out.	3. Replace.
Pump running but system not producing water.	1. Carbon pre-filter plugged.	1. Replace filter cartridge.
	2. Inlet solenoid valve not working.	2. Repair or replace solenoid valve.
System does not shut off.	1. High pressure switch not working.	1. Repair or replace high pressure switch.
Abnormal pump cycling noise.	1. Pre-filter plugged or low feed water pressure.	1. Replace filter or adjust or sufficient feed water.
No water to drain.	1. Plugged drain flow restrictor.	1. Replace drain flow restrictor.
Water has bad taste.	1. Post filter (CB-10) is exhausted.	1. Replace post filter
Leaks	1. Tubing connections not installed properly.	1. Re-install tubing into fitting.
	2. Defective tubing.	2. Cut damage section of tubing and re-install.

Spare Parts List

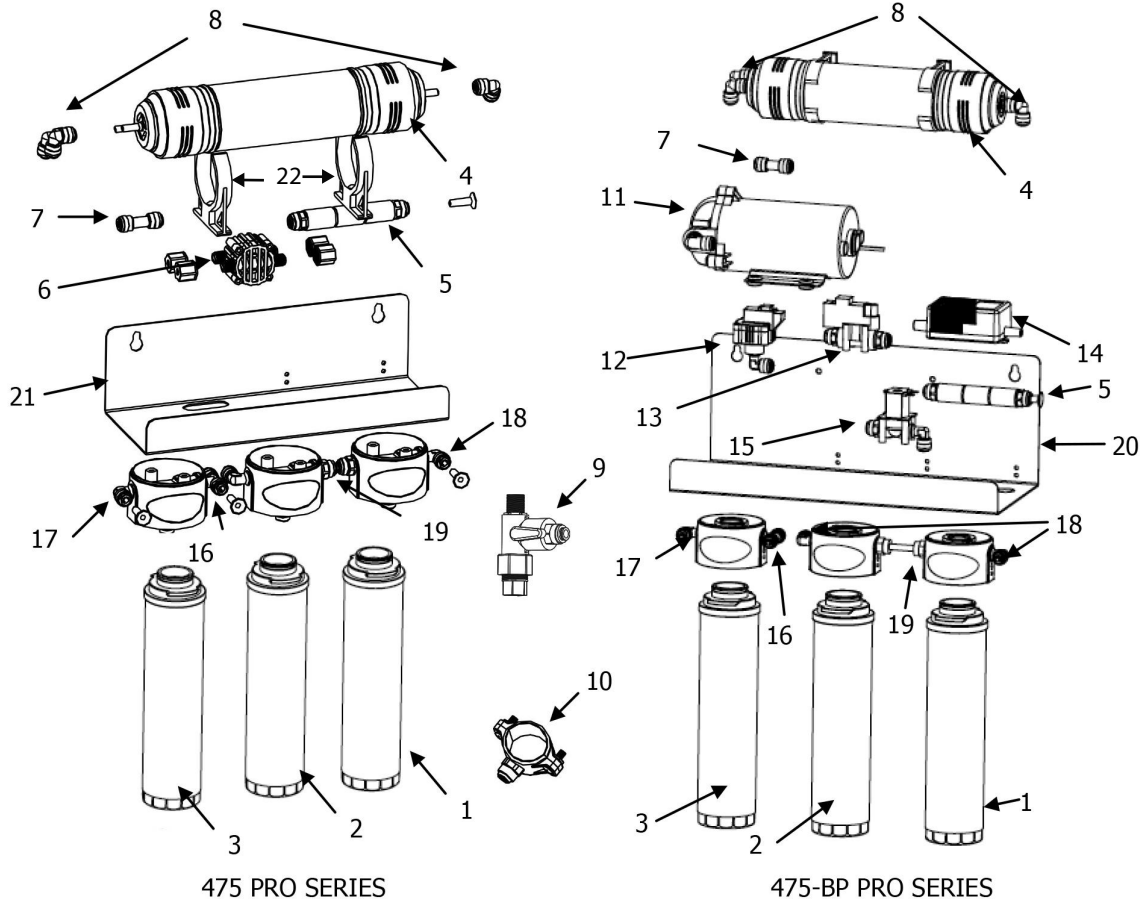

1	65010086	SEDIMENT FILTER SED-10
2 / 3	65010088	CARBON FILTER COC-10
2 / 3	65010089	CARBON FILTER GAC-10
4	70010014	75 GPO MEMBRANE
5	70030028	FLOW CONTROL 300ML/MIN
6	70030004	RO SHUTOFF VALVE 1/4" QC
7	65030028	PRODUCT WATER CHECK VALVE
8	80010041	UNION ELBOW 1/4
9	60095649	T Adapter
10	65030027	WASTE WATER SADDLE
11	70030022	BOOSTER PUMP 475 PRO SERIES
12	70030032	LOW PRESSURE SWITCH
13	70030041	TANK CUT-OUT PRESSURE SWITCH
14	70030026	TRANSFORMER (475 BOOSTER PUMP)
15	70030027	SOLENOID VALVE (475 PRO SERIES)
16	80010074	BRANCH TEE 3/8XI / 4NPTF
17	80010046	ELBOW 3/8XI / 4NPTF
18	80010037	ELBOW 1 / 4XI / 4NPTF
19	80010001	MALE CONNECTOR 1 / 4XI / 4NPTF
20	65030026	BRACKET 475-BP PRO SERIES
21	65030025	BRACKET 475 PRO SERIES
22	60095699	MOUNTING CLIP MEMBRANE HOUSING
	70020002	TANK 3.0 GALLON (NOT SHOWN)
	80010017	FAUCET CONNECTOR 3/8"X7/16-24UNS
		AIR GAP LONG REACH FAUCET (NOT SHOWN)

Flow Diagrams

475 Pro-Series (No Pump)

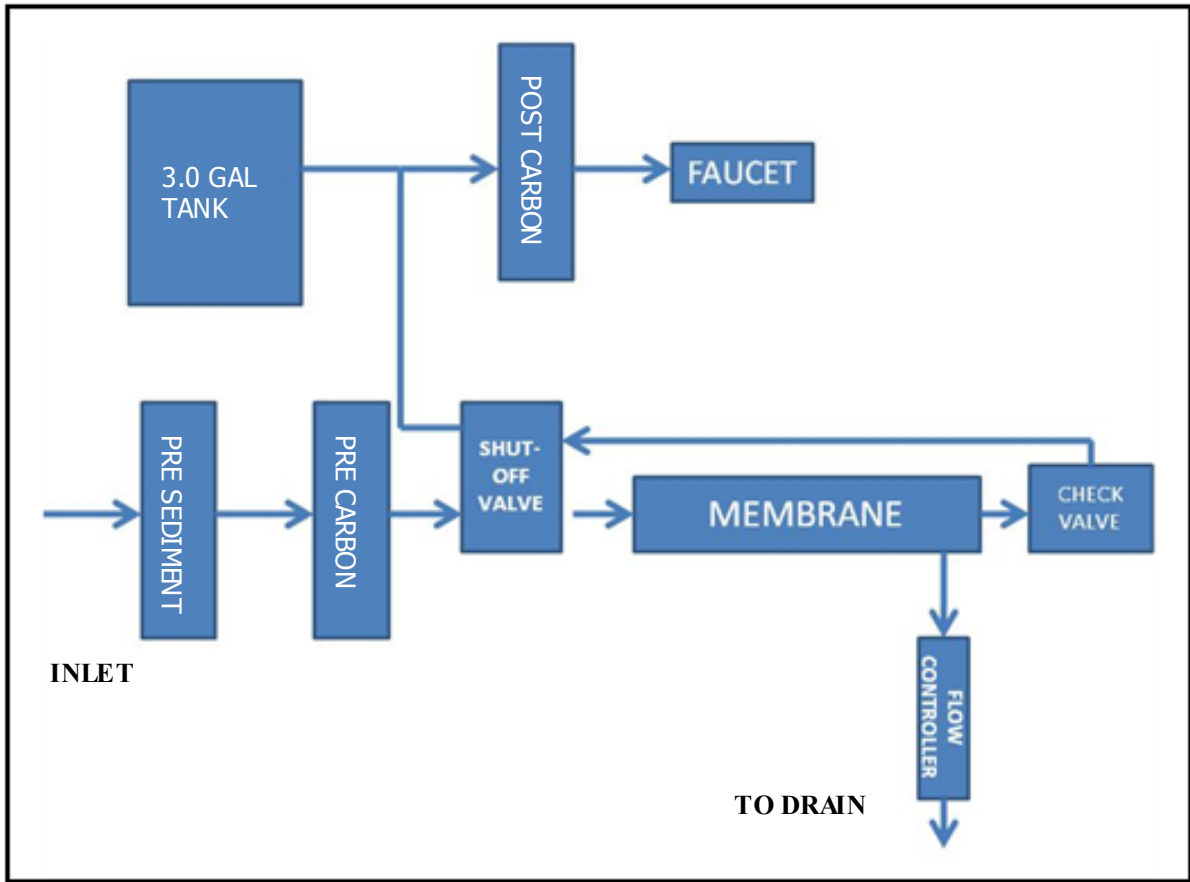

475BP Pro-Series (With Pump)

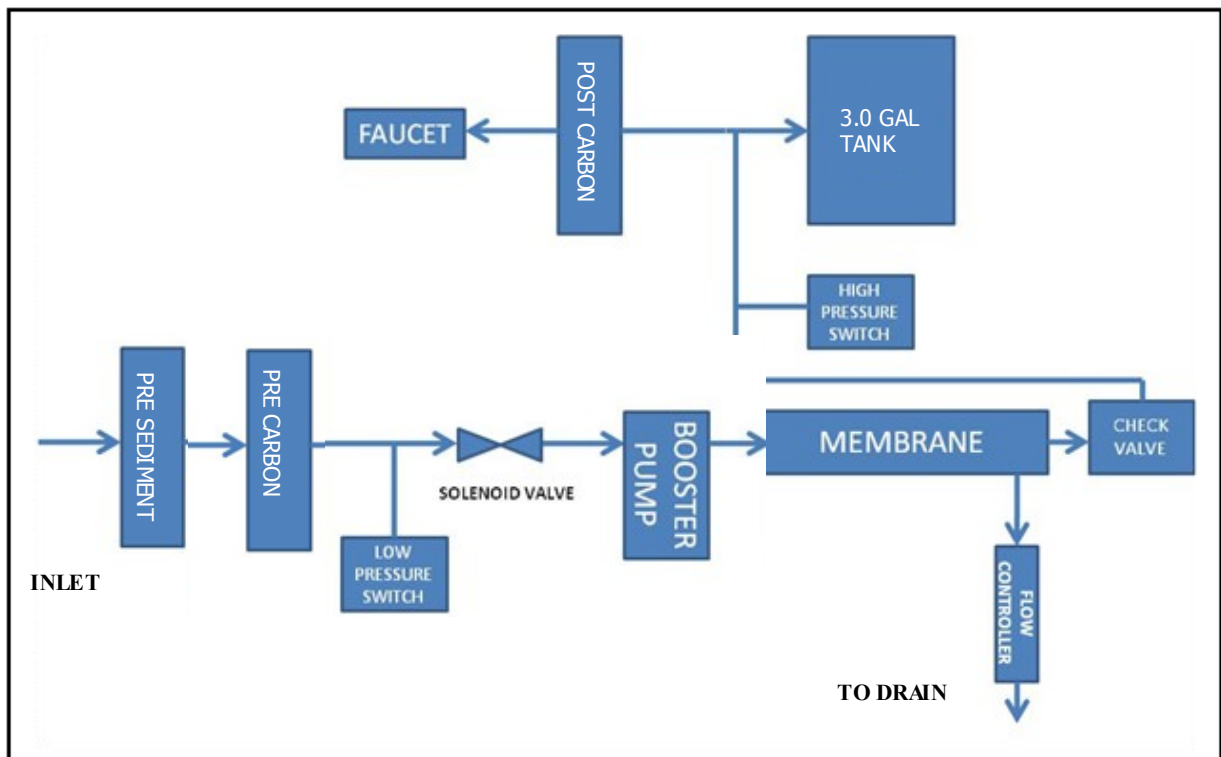

Demand Pump Diagram

475BP Pro-Series (With Demand Pump)

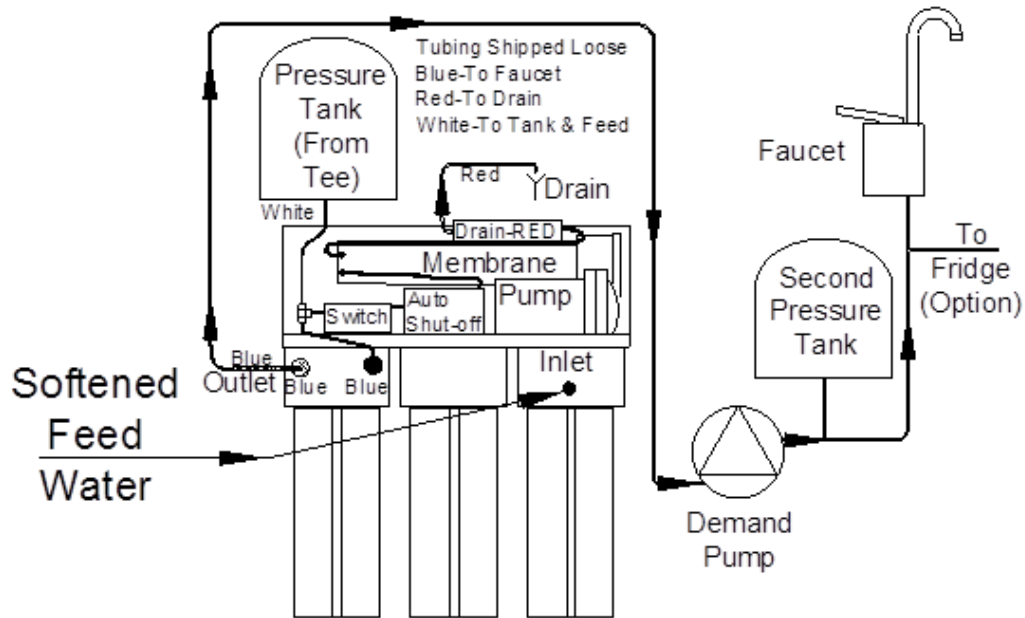

RO Unit c/w RO Pump, Demand Pump
& Two Pressure Tanks

Electrical Diagrams

Wiring Diagram 475BP Pro-Series (With Pump)

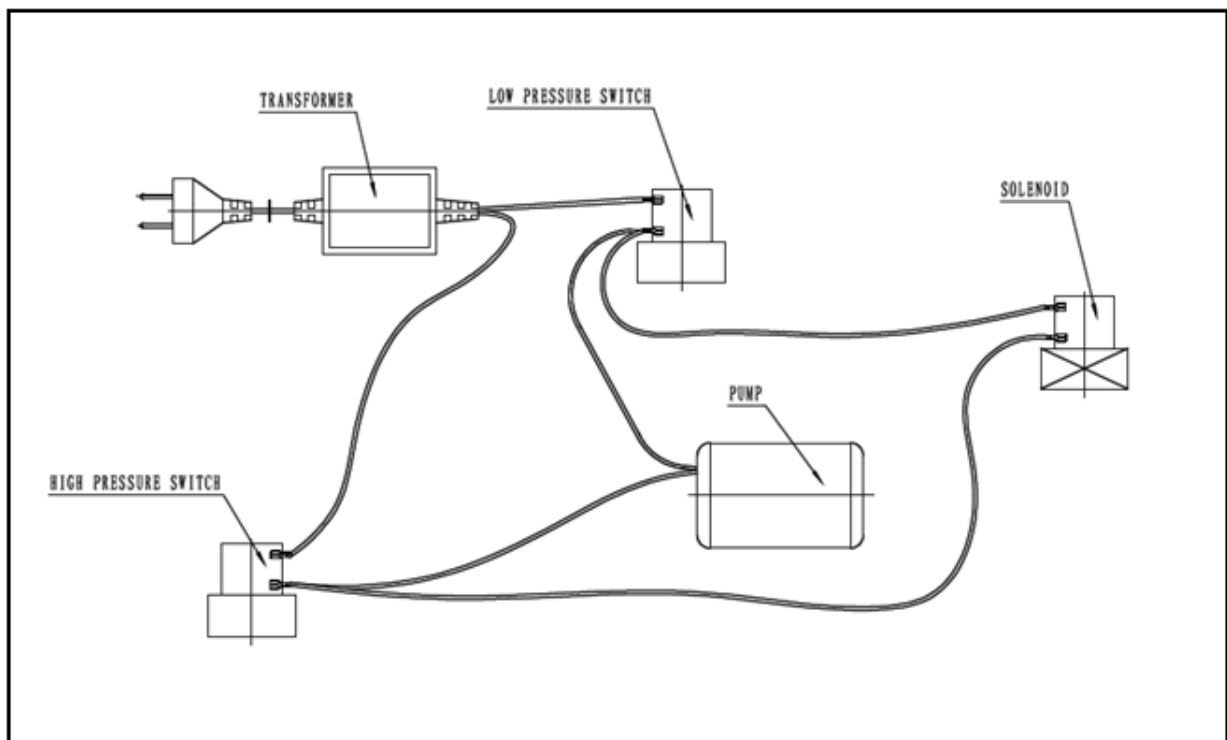

Operation Specifications

WATER SUPPLY	CHLORINATED / NON-CHLORINATED
INLET WATER PRESSURE	40 - 100 PSI
INLET WATER PRESSURE (BOOSTER PUMP MODELS)	15—60 PSI
TEMPERATE	40 - 100F
PH	3.0 -11.0
MAX. TDS	1000 MG/L
TURBIDITY	< 1.0 NTU
MAX SDI	<4.0
HARDNESS	< 5 GPG
IRON	<0.1
MANGANSESE	<0.05
HYDROGREN SULFIDE	0.00

Warranty

475 PRO Systems (excluding cartridge filters and membrane) are warranted to be free from defects in materials and workmanship under normal use within the operation specifications for a period of two (2) years from the date of manufacture or date of purchase when verified by a bill of sale.

Canature WaterGroup will replace any part which fails two (2) years from date of manufacture as indicated by the serial number or date code, provided the failure is due to a defect in material or workmanship. The only exception shall be when proof of purchase or installation is provided and then the warranty period shall be from the date thereof.

Canature WaterGroup assumes no responsibility for consequential damage, labour or expense incurred as a result of a defect or for failure to meet the terms of these guarantees because of circumstances beyond its control.

Toll Free: 1-877-288-9888

Regina, SK Cambridge, ON Carmel, IN Pottstown, PA Phoenix, AZ